

ASSEMBLY AND INSTALLATION INSTRUCTIONS

W0156 / W0303

WARNING: TO AVOID RISK OF ELECTRICAL SHOCK, BE SURE TO SHUT OFF POWER WHILE INSTALLING OR SERVICING THIS FIXTURE.

NOTES: 1. Before installing, consult local electrical codes for wiring and grounding requirements.
2. READ AND SAVE THESE INSTRUCTIONS.

Hardware Package (included):

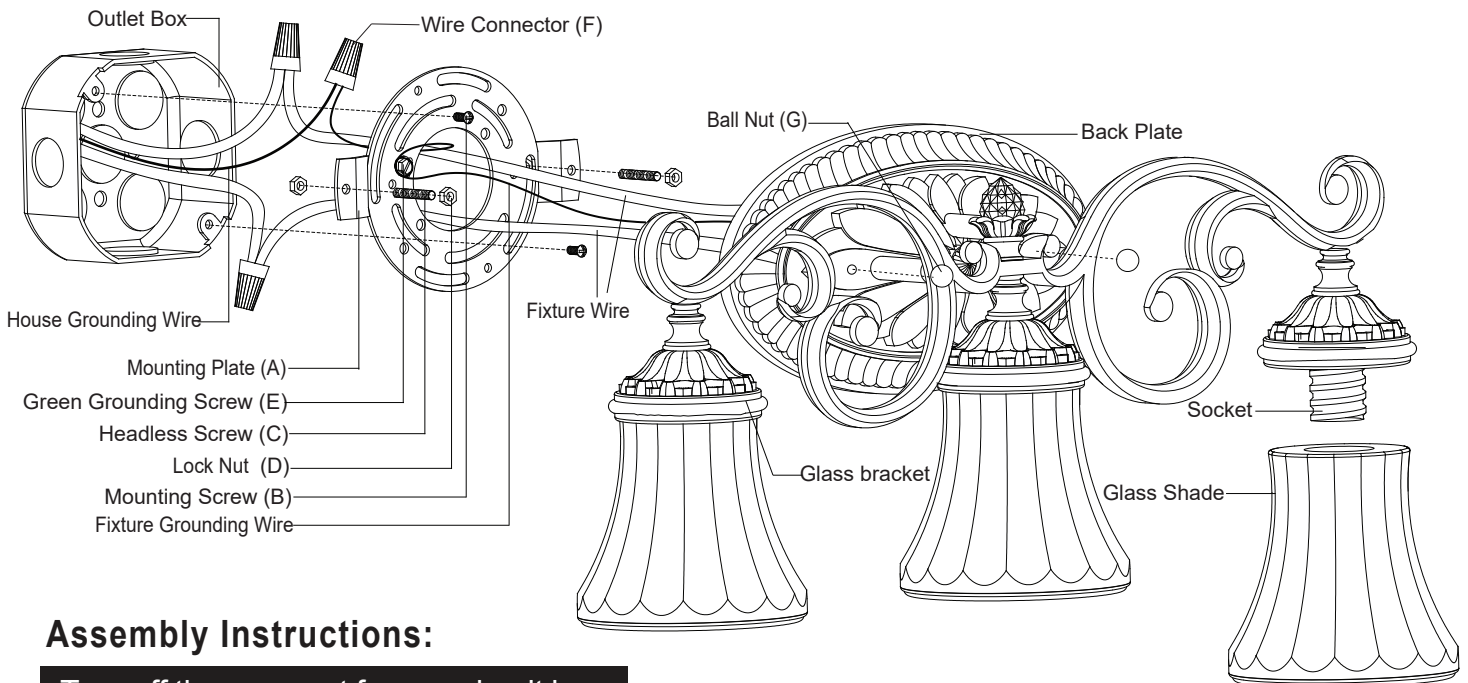
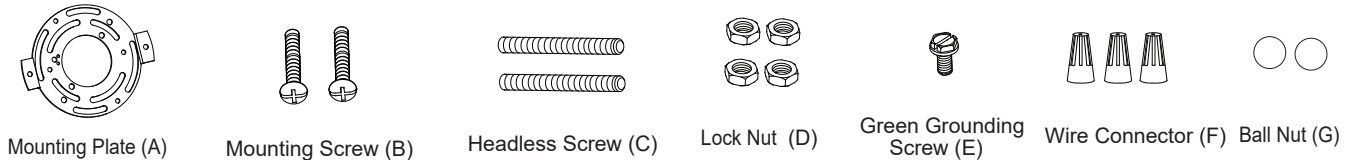

Assembly Instructions:

Turn off the power at fuse or circuit box.

1. Thread two headless screws through the mounting plate, then secure them with four lock nuts (two on each side of the mounting plate). Adjust the length of the headless screws if necessary.
Note: Make sure that the headless screws are lined up horizontally, in order to ensure that the fixture will be level.

2. Attach the mounting plate to the outlet box by using two mounting screws.

3. Pull out the source wires from the outlet box. Make wire connections using wire connectors as follows:

---Connect the hot wire (usually black insulation) from the fixture to the black wire from the power source.

---Connect the neutral wire (usually white insulation) from the fixture to the white wire from the power source.

---Attach the fixture grounding wire (usually bare wire) to the mounting plate with the green grounding screw, then connect it to the house grounding wire with a wire connector. If your outlet box does not have a house grounding wire, then wrap the fixture grounding wire around the green grounding screw.
Carefully tuck the wires back into the outlet box.

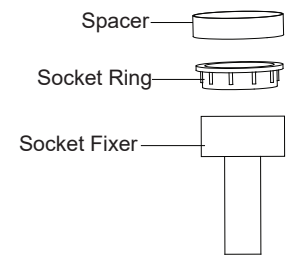

Bulb Type A Max. 100W (not included)

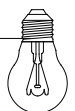

4. Attach the back plate to the mounting plate by inserting the headless screws, then secure it with the ball nuts.
5. Attach the glass shades onto the glass brackets and secure them with the spacers and socket rings, using supplied socket fixer.
6. Install bulbs (not included). See relamping label at socket area or packaging for maximum allowed wattage.

Turn on the power at fuse or circuit box.

The following parts are available for re-order if damaged or missing.

Spare Parts List:

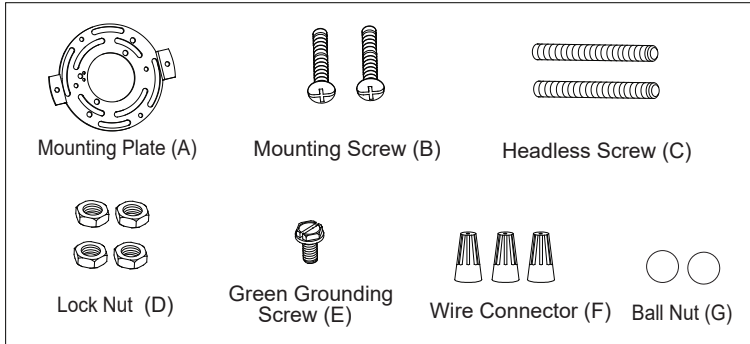

→ Assembly Kit
 5290MM (1 SET) for W0156
 5955MM (1 SET) for W0303

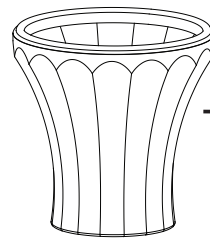

→ Glass Shade
 9700AB (1 PC) for W0156
 10014EW (1 PC) for W0303

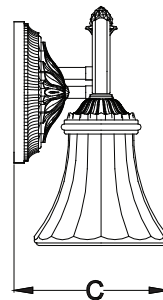
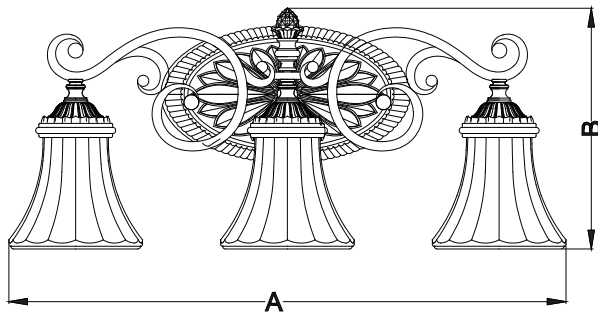

A: 23"

B: 10-1/2"

C: 6-1/2"