

PACKAGE CONTENTS

PART	DESCRIPTION	QUANTITY
A	Fixture	1
B	Canopy	1

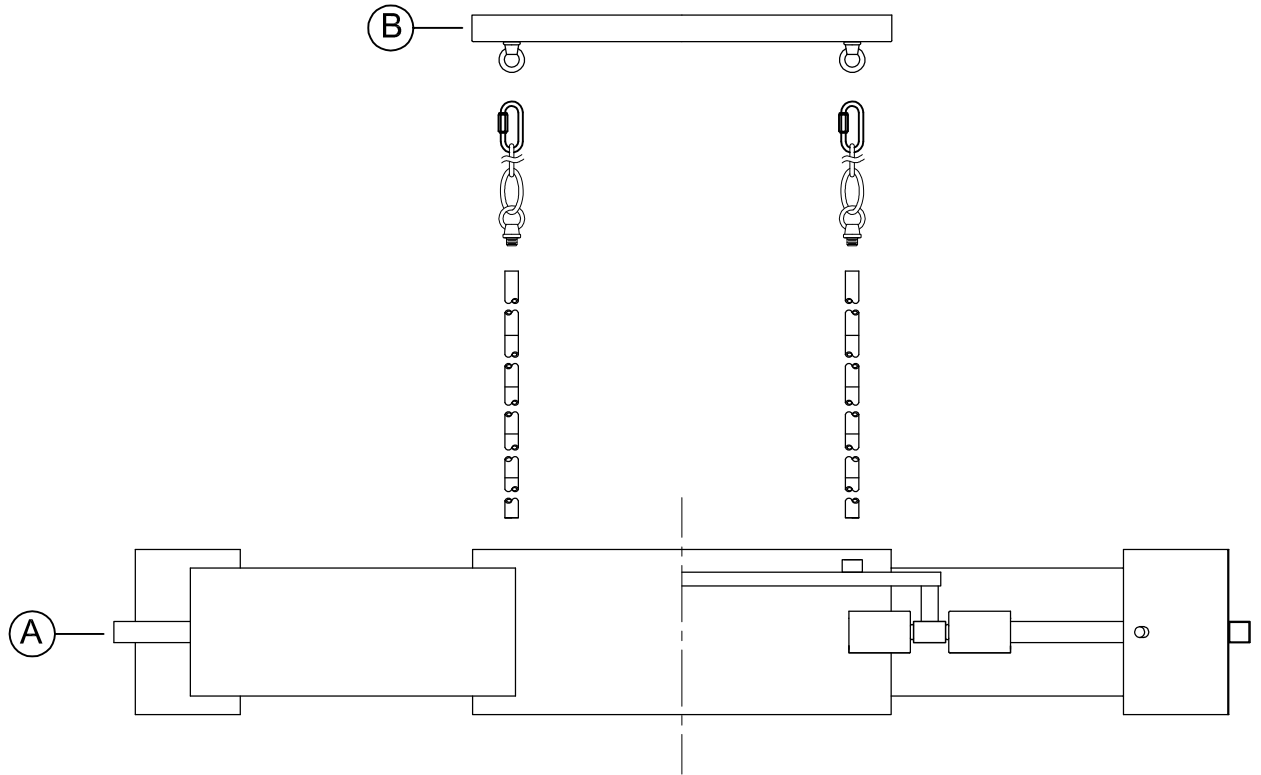

HARDWARE CONTENTS (not actual size)

AA	BB	CC	DD	EE	FF	GG	HH	JJ	KK	LL	MM	NN	PP
Wire Nut	Back plate	Screw (#8)	Flat washer	Cylinder nut	Chain (6Links)	Chain Loop (1/8IP)	12" Pipe (1/8IP)	6" Pipe (1/8IP)	Nipple (1/8IP)	Quick link	Screw #10-32	Toggles	Hex nut (1/8IP)
Qty:3	Qty:1	Qty:1	Qty:1	Qty:2	Qty:2	Qty:2	Qty:8	Qty:2	Qty:8	Qty:2	Qty:2	Qty:2	Qty:2



Missing parts? Please contact Customer Service at 1-800-446-9107,  
8am-8pm (Eastern), Monday - Friday



## SAFETY INFORMATION

Please read and understand this entire manual before attempting to assemble, operate or install the product.

**CAUTION:** Read instructions carefully and turn electricity off at main circuit breaker panel before beginning installation.

**CAUTION:** Risk of fire. Min. 90°C supply conductors. Consult a qualified electrician to ensure correct branch circuit conductor

**WARNING:** If any Special Control Devices are used with this Fixture, follow instructions carefully to assure full compliance with N.E.C. requirements. If there are any questions, contact a qualified electrical contractor.

**CAUTION:** All glass is fragile, use care when handling glass shades and bulbs.

## PREPARATION

1. Before beginning installation, make sure all parts are included using the contents diagrams from page 1. If any part is missing or damage, do not attempt to assemble, install or operate the product.
2. Estimated assembly time: 30 minutes.
3. Tools required for assembly (not included): Phillips screwdriver, pliers, wire stripper, safety glasses, electrical tape, ladder, drill.

## CARE AND MAINTENANCE

Shut off main power supply before cleaning product or changing light bulbs. To clean, wipe with damp cloth. Do not use abrasive cleaners or cleaners that contain alcohol.

## ASSEMBLY INSTRUCTIONS

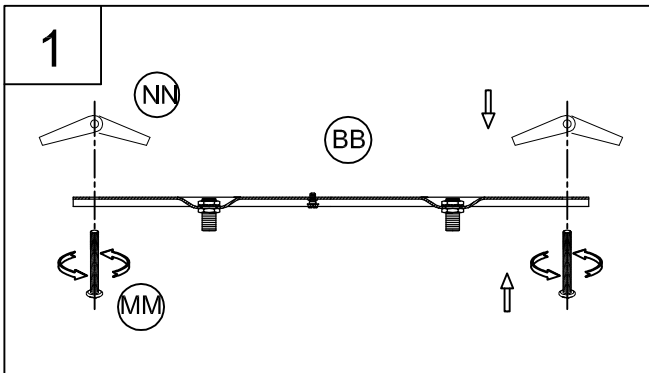

1. Loosely thread the screws (MM) and the toggles (NN) onto the back plate (BB).

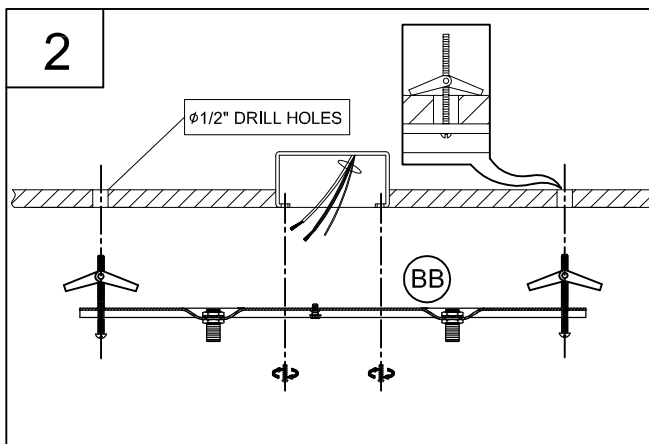

2. Line up the holes in the back plate (BB) with the holes in the junction box. Use a pencil to mark the locations of the two mounting holes. Remove the back plate from the wall.

Drill (2)  $\varnothing 1/2$  in. mounting holes in the wall for the toggles (NN). Line up the holes in the back plate (BB) with the drilled holes, press toggles (NN) into the mounting holes drilled and use screws (MM) securing tightly. Then use the mounting screws supplied with the junction box (not included) to secure the back plate (BB) to the junction box.

# ASSEMBLY INSTRUCTIONS

During this step, determine the hanging length of your fixture by removing chain links and stems and optionally cutting the electrical and ground wire to length.

Do NOT cut electrical or ground wires until this overall length is determined. Leave at LEAST 6 inches MINIMUM of wire length on the canopy ceiling side to allow for easy connections in step 5.

(Chain links can be spread open with 2 pairs of pliers. Twist the split link ends in opposite directions and close by squeezing them back together)

3. Determine the hanging height of the fixture (A) and adjust both chains (FF) at this time. Pass wires through stems (HH/JJ) and nipples (KK), tightening stems to assembly as you go to avoid twisting the wires. Pass wires through chain loop (GG) and tighten chain loop (GG) to stem assembly (HH).

Install one end of each of the equal length chains (FF) onto the fixture loops (GG). Close the chain links back together with the pliers. Open the quick link (LL), attach the other end of chain (FF) and canopy loop (B) onto the quick link (LL). Close the quick link. Be sure chains are not twisted and align evenly with one another. With the wires exiting the fastened loop (GG), weave the wire and ground wire through every third chain link (FF), having them exit up through the canopy loop (B) and out the back of the canopy (B).

With the chain links (FF) closed and all the loops (GG) fastened securely, have someone help you hold up the fixture by the canopy (B) and visually inspect the chain lengths, making sure fixture hangs evenly.

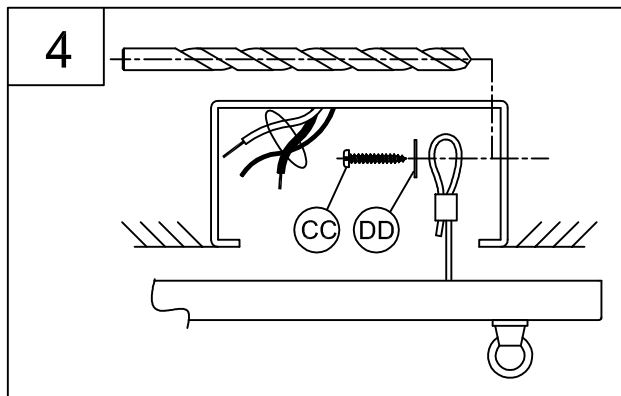
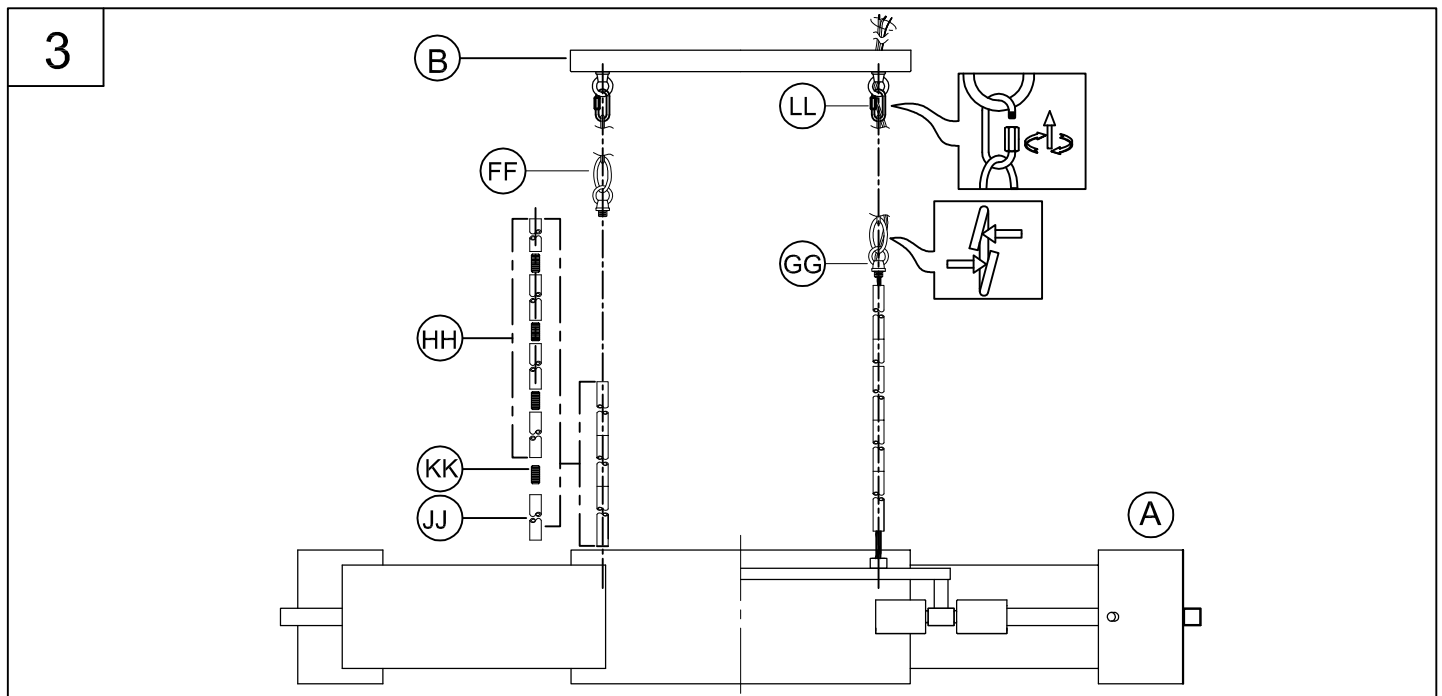

4. You now need to attach the fixture support cable. This cable will aid you in supporting the fixture during the wiring connection in step 5. You will need a helper to help hold up the fixture during this step.

Make sure the supply wire is out of the way from the drill for this step.

Use a #29 drill ( $\varnothing.136$ ) or (3.5mm) bit to create a mounting hole in the side of the junction box.

Next, using the self threaded screw (CC) and flat washer (DD) provided, secure the support cable into the hole you just drilled in the junction box. Tighten securely.

# ASSEMBLY INSTRUCTIONS

5

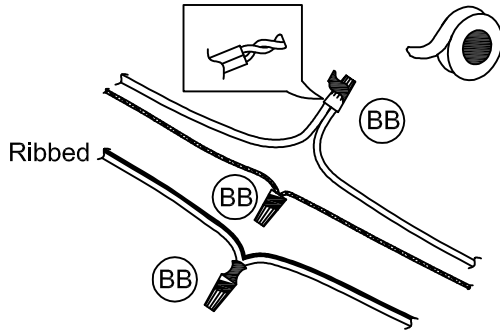

5. Strip 3/8" of insulation from the electrical wire ends. Using the wire nuts (BB), connect the RIBBED fixture wire to the WHITE supply wire from the outlet box; connect the SMOOTH fixture wire to the BLACK supply wire from the outlet box.

Connect the fixture ground wire and supply ground wire together using a wire nut, or fasten both to the ground screw on the mounting strap. Push all the wire connections carefully into the outlet box.

6

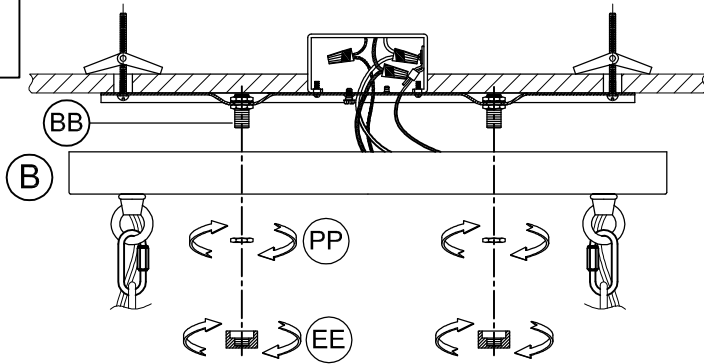

6. Position and attach the canopy (B) onto the nipple (BB) and use the hex nut (PP) to secure the canopy (B) tightly to the ceiling.

Next, install the cylinder nut (EE) onto the nipple (BB) to aesthetically hide the hex nut (PP). Tighten it securely to the nipple (BB).

7. Install the lamps (not included) into fixture sockets. Use 60-watt MAX incandescent medium base lamp, SBCFL or SBLED.

7

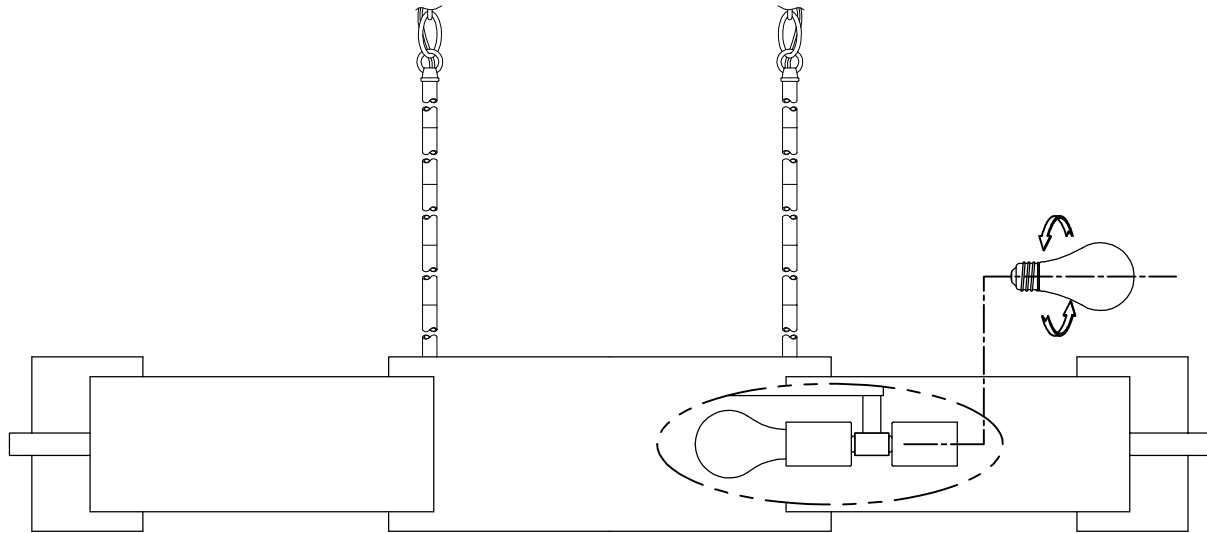

**WARRANTY AND EXCLUSIVE REMEDY:** Progress products, when properly installed and under normal conditions of use, are warranted to our customers only to be free from defects in material and workmanship at time of shipment. All warranty claims must be asserted within one year from date of purchase of the subject items; thereafter, warranty claims will not be honored. Customers' sole remedy for a warranty claim or otherwise shall be limited to repair or replacement of the subject product if it is shown to have been defective in material or workmanship at time of shipment. Progress's sole and maximum liability for a defective product shall never exceed the cost of the subject product. EXCEPT FOR SUCH A WARRANTY AND EXCLUSIVE REMEDY AS STATED (AND THE EXPRESS WARRANTY OF TITLE), WE DISCLAIM ALL OTHER WARRANTIES, WHETHER EXPRESS OR IMPLIED, AND SPECIFICALLY DISCLAIM THE IMPLIED WARRANTIES OF MERCHANTABILITY AND FITNESS FOR A PARTICULAR PURPOSE. IN NO EVENT SHALL WE BE LIABLE TO CUSTOMER IN WARRANTY, CONTRACT, NEGLIGENCE, STRICT LIABILITY OR OTHERWISE, FOR ANY DAMAGES, WHETHER INCIDENTAL OR CONSEQUENTIAL, WHICH ARE ALLEGED TO BE CAUSED BY ONE OR MORE OF OUR PRODUCTS, BEYOND THE COST TO THE CUSTOMER OF THE SUBJECT PRODUCT OR PRODUCTS. Therefore, the customer's sole and exclusive remedy against us for breach of the warranty, breach of contract or negligence or strict liability or otherwise shall be limited to repair or replacement of the subject product at our option (excluding installation and removal charges which shall not be our liability) or, if we choose, refund of the purchase price. In no case does our warranty and exclusive remedy extend to anybody other than our customers. Our customers are not authorized to extend warranties or remedies on our behalf to anyone. Such unauthorized extensions of warranties or remedies by the customer shall remain customer's responsibility. Customer is responsible for determining the suitability of our products for customer's use or resale, or for incorporating them into objects or for applications which customer designs, assembles, constructs or manufactures.

# Instructions d'Assemblage et Installation

Mise en garde: Lire les instructions avec soin et couper le courant au disjoncteur central avant de commencer l'installation.

\*\*\*\*\*  
**MISE EN GARDE:** Lire les instructions avec soin et couper le courant au disjoncteur central avant de commencer l'installation.

**MISE EN GARDE:** Risque d'incendie. Min 90°C conducteurs d'alimentation. Consulter un électricien qualifié pour assurer le bon conducteur de circuit de dérivation.

**AVERTISSEMENT** - S'il y a d'autres mécanismes régulateurs qui s'emploient avec ce dispositif, suivre soigneusement les instructions pour satisfaire aux exigences NEC. Si vous avez des questions, consulter un électricien qualifié.

**MISE EN GARDE** - Le verre est toujours fragile; maniez le(s) composant(s) et/ou l' (les) ampoule(s) avec prudence.

\*\*\*\*\*

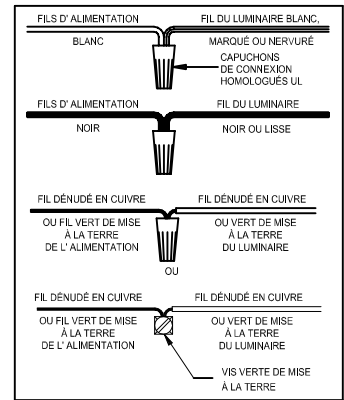

# Instrucciones de ensamblaje e instalación

Precaución: Lea cuidadosamente las instrucciones y desconecte la electricidad del cortacircuitos principal antes de iniciar la instalación.

\*\*\*\*\*  
**PRECAUCIÓN:** Lea cuidadosamente las instrucciones y desconecte la electricidad del cortacircuitos principal antes de iniciar la instalación.

**PRECAUCIÓN:** Riesgo de fuego. Min. 90°C los cables de suministro. Consulte a un electricista calificado para asegurarse de que el conductor del circuito derivado correcto.

**ADVERTENCIA** - Si usa algún dispositivo especial de control con este aparato de luz, siga las instrucciones cuidadosamente para asegurar la completa conformidad con los requisitos N.E.C. Si existe alguna duda, contacte un electricista calificado.

**PRECAUCION** - El vidrio es frágil; tenga cuidado al manipular el (los) elemento(s) de vidrio y/o la(s) bombilla(s).

\*\*\*\*\*

